

# Maßzeichnungen outdoor living

**Bronx** (Feuerskulptur)

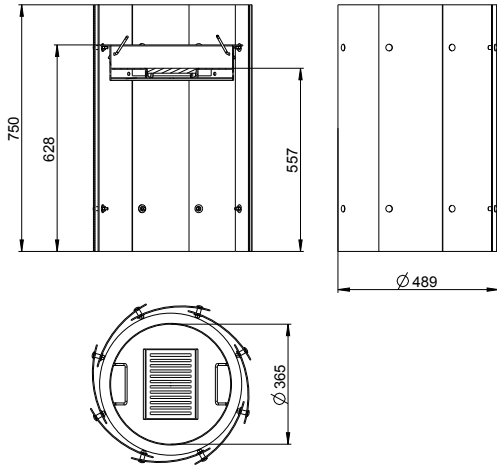

**Camp** (Feuerskulptur)

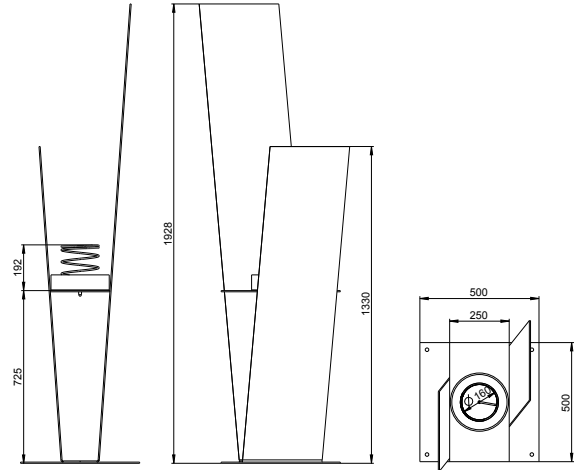

**Cruso** (Feuerskulptur)

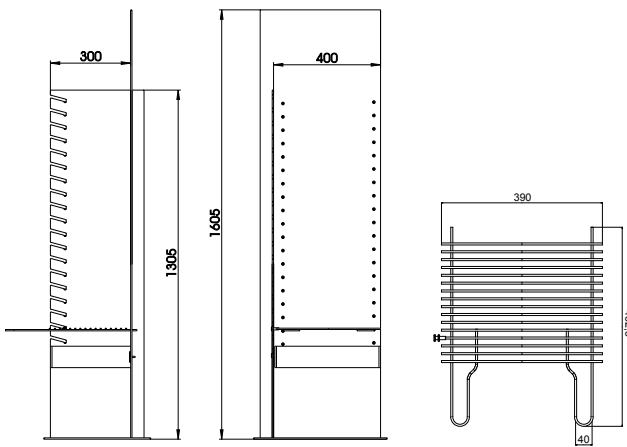

## Zubehör für Bodenbefestigung (optional für **Cruso**)

Adapterplatte

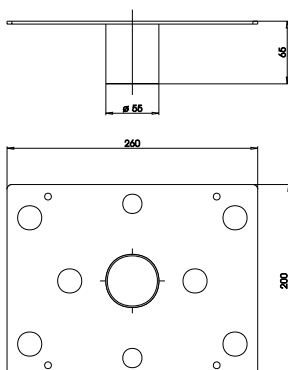

Schraubfundament

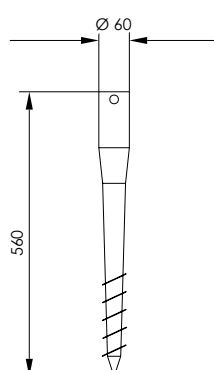

# Maßzeichnungen outdoor living

**Favi** (Feuerskulptur)

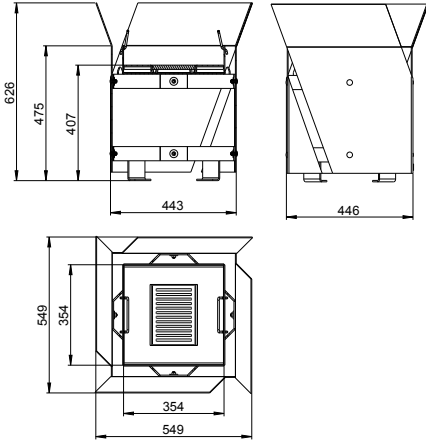

**feuer.werk** (Gartenrost)

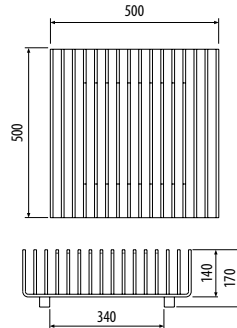

**Gryll** (Feuermodul)

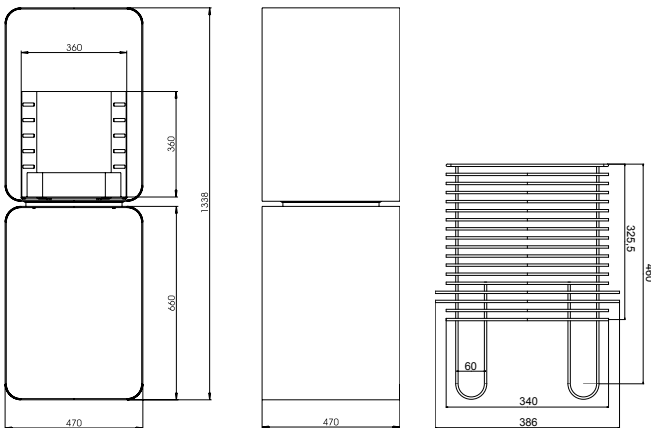

**Manitu** (Feuerskulptur)

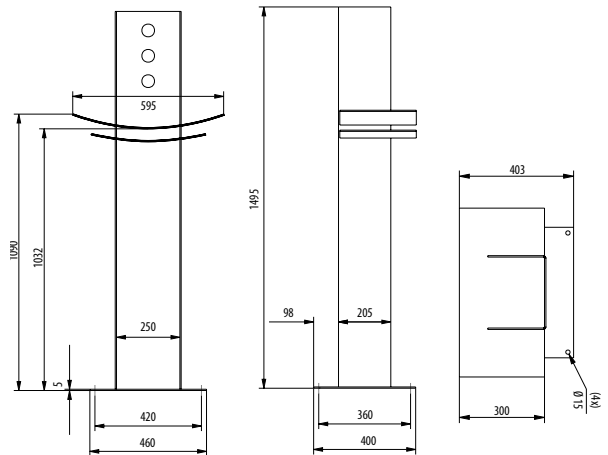

**Wing** (Feuerschale)

